

Internal Assessment Test - II

Sub:	Power Generation and Economics	Code:	18EE42
Date:	24/06/2021	Duration:	90 mins
		Max Marks:	50
		Sem:	4
		Branch:	EEE
Answer Any FIVE FULL Questions			

		Marks	OBE	
			CO	RBT
1.	Explain the functions of the following in a thermal plant (i)Air preheater, (ii)Boiler, (iii) Condenser, (iv) Reheater, (v) Economizer	[10]	CO2	L2
2.	Explain with a line-diagram, fuel handling system of a thermal power plant.	[10]	CO2	L2
3	With a neat sketch explain fluidized bed combustion. Mention its advantages	[10]	CO2	L2
4.	What are the four different system used for ash handling plant in thermal power plant, Explain with neat sketch.	[10]	CO2	L2
5.	Explain the working of diesel power plant with neat schematic diagram.	[10]	CO2	L2
6.	Explain the principle of working of a gas-turbine plant. Also explain open cycle and closed cycle gas turbines.	[10]	CO2	L2
7.a	List out and explain the points to be considered for site selection of diesel electric plant?	[5]	CO2	L2
7.b	Write a short note on Electrostatic precipitator.	[5]	CO2	L1

**1. (i)Air preheater :**

- The use of air preheater is more economical with pulverised fuel boilers because the temperature of flue gases going out is sufficiently large and high air temperature (250-350°C) is always desirable for better combustion.
- The use of water cooled furnaces and a feed water heater has also resulted in the increasing use of air preheaters.
- An air preheater should have high thermal efficiency, reliability of operation, less maintenance charges, should occupy small space, should be reasonable in initial cost and should be accessible.

- In order to avoid corrosion of the air preheaters, the flue gases should not be cooled below the dew point.
- This can be achieved by passing some air around the heaters or by recirculating air from the heater outlet to the forced draught fan inlet.
- The air pre-heaters are basically of two types viz., recuperative (plate type or tubular type) and regenerative types.
- Recuperative type air preheaters are continuous in action while the regenerative type are discontinuous in action and operates on cycle.
- In recuperative type of heaters, the two fluids are separated by heat transfer surface, one fluid flowing constantly on one side and the other fluid on the other side of the surface.

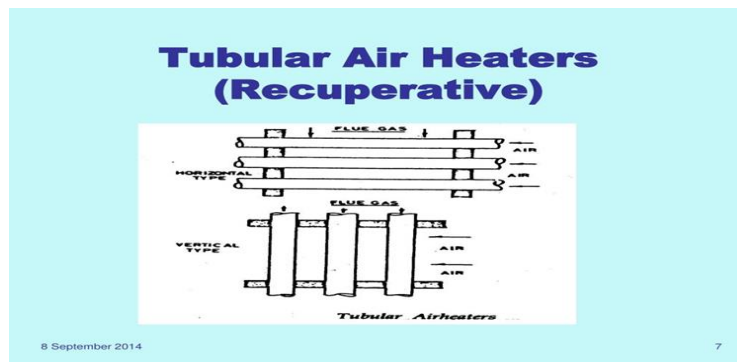
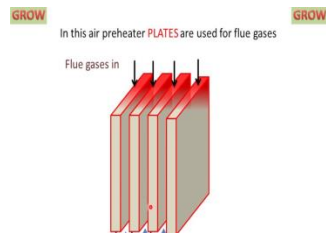

Air – preheater

## (ii)Boiler

- Boilers or steam generators convert water into steam and form one of the major equipments in a steam power plant.
- Boilers used in steam power plants are of two types namely (a)fire tube boilers and (b)water tube boilers.
- In fire tube boilers the tubes containing hot gases of combustion inside are surrounded with water while in water tube boilers the water is inside the tubes and hot gases outside the tubes.
- Fire tube boilers are compact in size, have low initial cost and have the ability to raise rapidly large quantities of steam per unit area of fire grate but have the following drawbacks.
- As water and steam, both are in the same shell, higher pressure of steam are not possible, the maximum pressure which can be had is about  $17.5 \text{ kg/cm}^2$  and with a capacity of 15,000 kg of steam per hour.
- For higher pressures or higher rates of evaporation, the shell and fire tube boilers become extremely heavy and unwieldy.
- In the event of a sudden and major tube failure, steam explosions may be caused in the furnace due to rush of high pressure water into the hot combustion chamber which may generate large quantities of steam in the furnace.

- Fire tube boilers use is, therefore, limited to low cost, small size and low pressure (to about 10 kg/cm<sup>2</sup>) plants.
- For central steam power plants of large capacity water tube boilers are used.
- Water tube boilers essentially consist of drums and tubes.
- The tubes are always external to drum.
- In comparison to fire tube boilers the drums in such boilers do not contain any tubular heating surface, so they can be built in smaller diameters and consequently they will withstand high pressure.

### (iii)Condenser

- Steam, after expansion through the prime mover, goes through the condenser which condenses the exhaust steam and also removes air and other non-condensable gases from steam while passing through them.
- The recovery of exhaust steam in the condenser reduces the make-up feed water that must be added to the system, from 100% when exhausted to atmosphere, to about 1-5% and thereby reduces considerably the capacity of water treatment plant.
- The exhaust pressure may be lowered from the standard atmospheric pressure to about 25 mm of Hg absolute and thereby permitting expansion of steam, in the prime mover, to a very low pressure and increasing plant efficiency.
- Maintenance of high vacuum in the condenser is essential for efficient operation.

Condensers are of two types namely (a)jet or contact condensers and (b)surface condensers.

- The essential difference between a jet condenser and a surface condenser is that in the former, the exhaust steam mixes with the cooling water and the temperature of the condensate and the cooling water is the same when leaving the condenser
- The condensate cannot be recovered for use as feed water to the boiler
- Heat transfer is by direct conduction
- In the latter i.e., in surface condenser, the exhaust steam and cooling water do not mix with each other, the water being circulated through a nest of tubes, the heat transfer being by convection.

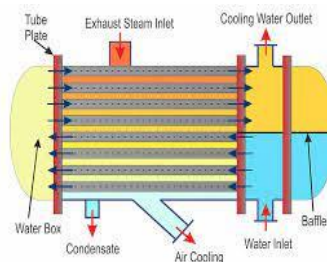
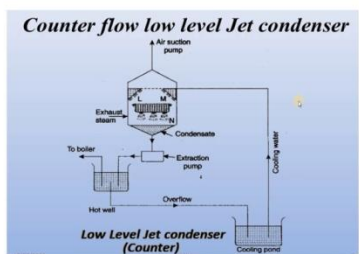

## Counter flow low level Jet condenser & Down flow Surface condenser

### (iv) Reheater

- The function of the re-heaters is to re-superheat the partly expanded steam from the turbine.
- This is done so that the steam remains dry as far as possible through the last stage of the turbine.
- Modern plants have re-heaters as well as super heaters in the same gas passage of the boiler.
- They can also be of combination type using both radiant and convective heating.

### (v) Economizer

- When the combustion gases leave the boiler after giving most of their heat to water tubes, super heater tubes and re-heater tubes, they still possess lot of heat which should be recovered by means of some devices.
- Economiser and air preheater are such devices which recover the heat from the flue gases on their way to chimney and raise the temperature of feed water and air supplied for combustion respectively.
- Economiser raises boiler efficiency (by 10-12%), causes saving in fuel consumption (5-15%) and reduces temperature stresses in boiler joints because of higher temperature of feed water, but involves extra cost of installation, maintenance and regular cleaning and additional requirement of space.
- High cost of fuel consumption, high load factor and high pressure and temperature conditions, all justify the use of economiser.
- For pressure of 70 kg/cm<sup>2</sup> or more the economiser becomes a necessity.
- Economiser tubes are made of steel either smooth or covered with fins to increase the heat transfer surface area.
- The tubes can be arranged in parallel continuous loops welded to and running between a pair of water headers, or in return bend design with horizontal tubes connected at their ends by welded or gasketed return bends outside the gas path.
- The feed water flows through the tubes and the flue gases outside the tubes across them.
- The heat transfer from flue gases to feed water is by convection.
- The feed water should be sufficiently pure not to cause forming of scales and cause internal corrosion, and under boiler pressure.
- The temperature of feed water entering the economiser should be high enough so that moisture from the flue gases does not condense on the economiser tubes, which may absorb SO<sub>2</sub> and CO<sub>2</sub> from the flue gases and form acid to corrode the tubes.

- The temperature of the feed water entering the economiser is usually kept above 84°C. In a modern economiser, the temperature of feed water is raised from about 247°C to 276°C.

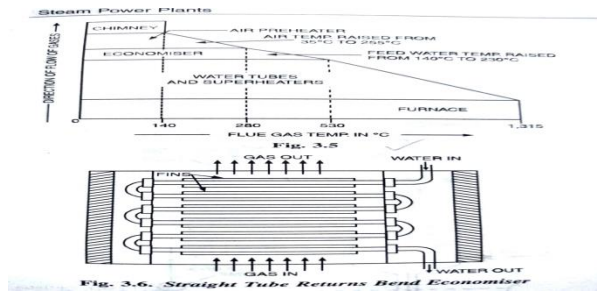

----- (10 Marks)

## 2. Fuel handling system of a thermal power plant

- Coal is the most commonly used fuel in thermal power plants
- Enormous amount of coal is burnt in a thermal power plant
- For example : A 200 MW power plant may require about 2000 tonnes of coal per day
- The cost of the coal may be as high as 60-70% of the total operation cost of the plant
- Therefore problems of coal handling in a thermal power plant require special considerations
- Coal can be handled manually or mechanically
- Mechanical handling is usually adopted as it is reliable, expeditious and economical
- Owing to large quantity of coal required to be handled everyday, mechanical handling has become absolutely necessary
- The main requirements of a coal handling plant are reliability, soundness and simplicity requiring a minimum of operatives and minimum of maintenance
- The plant should be able to deliver the required quantity of coal at destination during peak hours

The various stages in coal handling are :

- Unloading
- Transfer to dead storage or preparation plant
- Dead storage
- Reclamation
- Live storage
- Inplant handling
- Coal weighing

The coal is unloaded from the point of delivery by means of :

- Coal shakers or coal accelerators
- Rotary car dumpers or wagon trippers
- Grab buckets

The choice of equipment will depend upon the method of transportation adopted

The main equipment employed for taking the coal from the unloading site to the dead storage are :

- Belt conveyors
- Screw conveyors
- Bucket elevators
- Skip hoist
- Grab bucket conveyors
- Flight conveyors

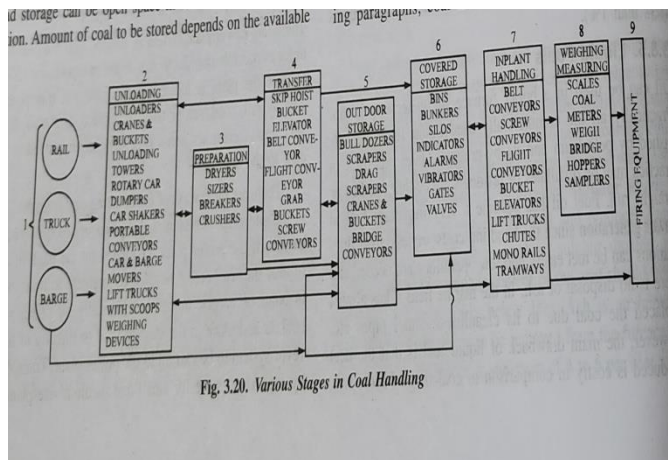

Fig. 3.20. Various Stages in Coal Handling

### Various Stages in Coal Handling

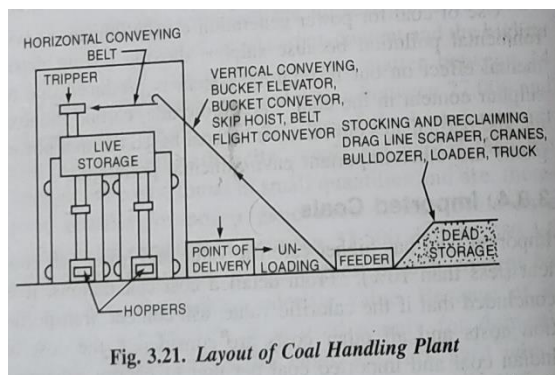

Fig. 3.21. Layout of Coal Handling Plant

### Layout of Coal Handling Plant

----- (10 Marks)

### 3. Fluidized bed combustion

- Fluidization is a new method of mixing fuel and air for obtaining combustion
- A fluidized bed maybe defined as the bed of solid particles behaving as a fluid
- It operates on the following principle
- When an evenly distributed air is passed upward through a finely divided bed of solid particles at low velocity, the particles remain undisturbed but if the velocity is steadily increased, a stage is reached when the individual particles are suspended in the air stream
- If the air velocity is further increased, the bed becomes highly turbulent and rapid mixing of particles occur which appear like formation of bubbles in a boiling liquid and a bed is said to be fluidized
- The velocity of air causing fluidization depends on a given particle size, range and density
- In a fluidized bed combustion, rapid mixing ensures uniformity of temperature
- The main advantage of such a combustion system is that municipal waste, sewage plant sludge, biomass, agricultural waste and other high moisture fuels can be used for generating heat
- A fluidized furnace has an enclosed space with a base having openings to admit air
- Crushed coal, ash and either crushed dolomite or limestone are mixed in the bed furnace and high velocity combustion air is then passed through the bed entering from the furnace bottom
- With the steady increase in the velocity of air, a stage will be reached when the pressure drop across the bed becomes equal to the weight per unit cross section of the bed and this critical velocity is called the **minimum fluidizing velocity**
- With the further increase in velocity of air, the bed will expand and allow passage of additional air, in the form of bubbles
- When the air velocity becomes 3 – 5 times the critical velocity, the bed resembles a violently boiling liquid
- The evaporator tubes of boiler are directly immersed in the fluidized bed and the tubes, being in direct contact with the burning coal particles producing very high heat transfer rates

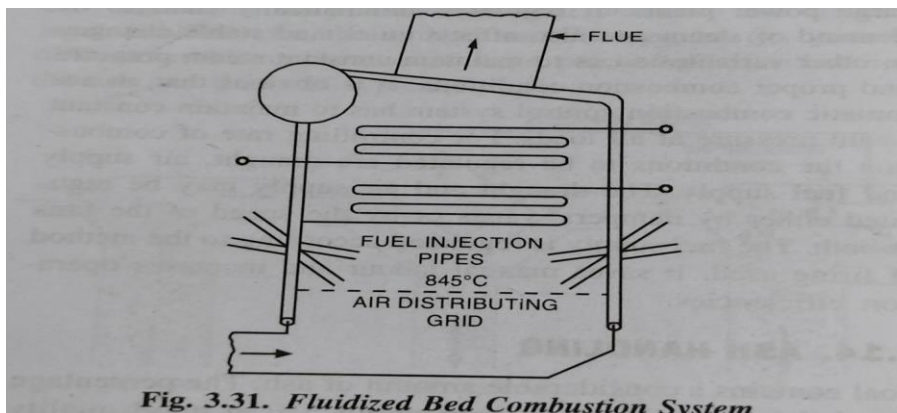

### **Advantages of Fluidized Bed Combustion System**

- High thermal efficiency.
- Easy ash-removal system.
- Short erection and commissioning.
- Fully automatic and safe operation.
- Multi-fuel operation.
- Reduced maintenance.
- Uniformity of temperature.
- Efficient operation at temperatures down to 150 degree Celsius.
- Reduced unit size and capital costs due to high heat transfer rates.
- Reduced fouling and corrosion of tubes due to low combustion temperatures.
- Reduced coal crushing costs.

The system can respond rapidly to changes in load demand due to quick establishment of thermal equilibrium between air and fuel particles in the bed. The operation of Fluidized Bed combustion at lower temperature helps in reducing air pollution.

------(10 Marks)

### **4. Ash handling systems in thermal power plant**

- Coal contains a considerable amount of ash.
- The percentage of ash in the coal varies from about 5% in good quality coals to about 40% in poor quality coals.
- For removal of ash from the boilers and its disposal to the suitable site is quite difficult and quite elaborate equipment is required.

Ash handling comprises the following operations:

- 1) Removal of ash from the furnace ash hoppers.
- 2) Transfer of this ash to a fill or storage.
- 3) Disposal of stored ash.

The modern ash handling systems used in large steam power plants are:

- 1) Belt conveyor system
- 2) Pneumatic system
- 3) Hydraulic system
- 4) Steam jet system



### Belt Conveyor System

- In this system ash cooled by water seal falls on the belt conveyor and is carried out continuously to the ash bunker.
- The ash is then removed to the dumping site from the ash bunker with help of trucks.

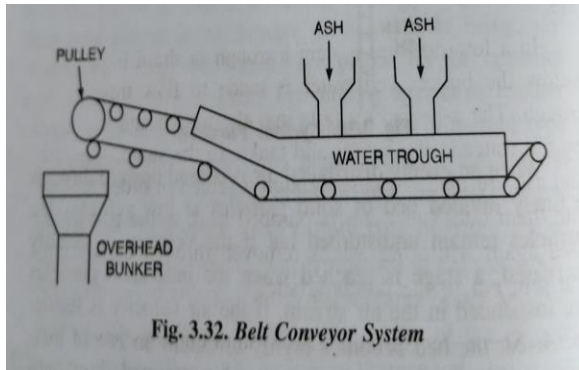

### Pneumatic System

- In this system ash from the boiler furnace outlet falls into a crusher where a larger ash particles are crushed to small sizes.
- The ash is then carried by a high velocity air or steam to the point of delivery.
- Air leaving the ash separator is passed through filter to remove dust etc.

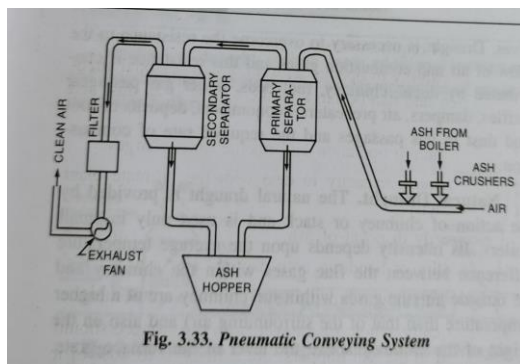

### Hydraulic system

- In this system a stream of water carries ash along with it in a closed channel and disposes it off to the proper site.
- This system can be used for large capacity power plants where the ash is to be disposed off over long distances.
- This is a healthy, clean, dustless and completely enclosed system.

Hydraulic systems are of two types:

- 1) High pressure system
- 2) Low pressure system

High pressure system operates intermittently whereas low pressure system is a continuous one.

### Steam Jet System

- This system employs jets of high pressure blowing in the direction of ash travel through a conveying pipe in which the ash from the boiler ash hoppers is fed chilled iron or nickel alloy are used in lining the pipe as ash is abrasive and travels at a high speed.
- This system is employed in small and medium sized plants.

------(10 Marks)

## 5. Working of Diesel power plant

Main components of Diesel Power Plant are :

- Engine
- Engine starting system
- Engine fuel system
- system
- Engine lubrication Engine air intake system
- Engine exhaust system
- Engine cooling system

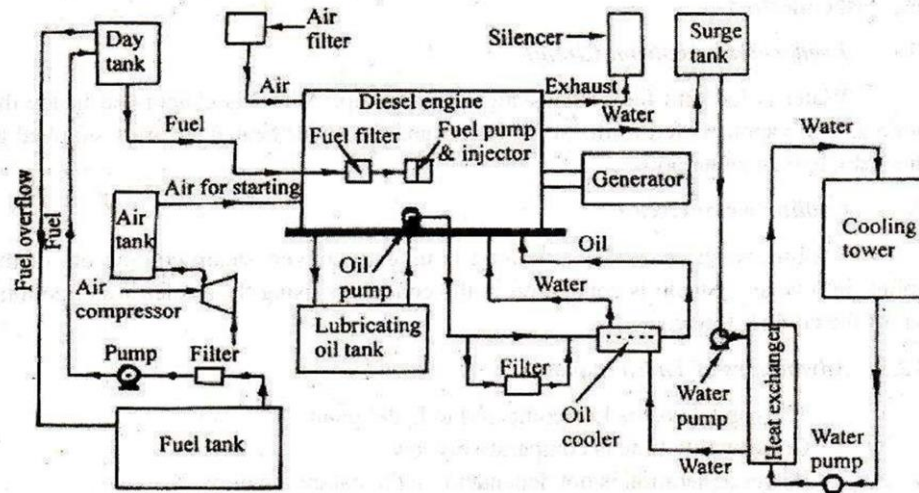

**Diesel Electric Stations**

### Engine:

- Develops power , coupled to the generator

### Engine starting system :

- To start the engine from cold by supply compressed air , enables engine to rotate initially
- Storage battery
- Compressed air tanks
- Self starter

**Engine fuel system :**

- Fuel storage tanks
- Fuel transfer pump :
  - fuel from delivery point to storage to engines
- Strainers:
  - To ensure clean fuel
- Heaters:
  - Heating during winter
- Connecting pipes

**Engine air intake system :**

- Air filters :
- To remove dust from air sent to engine
- Ducts
- Superchargers :
  - Increases pressure of air to the engine for higher output
  - Driven by the engines

**Engine exhaust system :**

- Silencers
- Reduces noise level
- Connecting ducts
- Heat in exhaust gases are transferred to oil or air on input side

**Engine cooling system :** To carry heat from engine cylinder to keep it cool

- Coolant pumps :
- Circulates water through the cylinder

- Cooling towers / spray ponds :
- To cool off the water
- Water treatment / filtration plant
- Connecting pipe work

**Engine lubrication system** : to reduce friction / wear and tear of moving parts

- Lubricating oil pumps
  - Oil tanks
  - Filters
  - Coolers
  - Purifiers
  - Connecting pipe work
- The purpose of the lubrication system is to reduce the wear of the engine moving parts .part of the cylinder such as piston shafts , valves must be lubricated.
  - Lubrication also helps to cool the engine.

------(10 Marks)

## 6. Principle of Working of a Gas-Turbine plant

1. Air-fuel mixture ignites:

The gas turbine compresses air and mixes it with fuel that is then burned at extremely high temperatures, creating a hot gas.

2. Hot gas spins turbine blades:

The hot air-and-fuel mixture moves through blades in the turbine, causing them to spin quickly.

3. Spinning blades turn the drive shaft:

The fast-spinning turbine blades rotate the turbine drive shaft.

4. Turbine rotation powers the generator:

The spinning turbine is connected to the rod in a generator that turns a large magnet surrounded by coils of copper wire.

5. Generator magnet causes electrons to move and creates electricity:

The fast-revolving generator magnet creates a powerful magnetic field that lines up the electrons around the copper coils and causes them to move.

The movement of these electrons through a wire is electricity.

- As hot combustion gas expands through the turbine, it spins the rotating blades.
- The rotating blades perform a dual function: they drive the compressor to draw more pressurized air into the combustion section, and they spin a generator to produce electricity.
- In order to generate electricity, the gas turbine heats a mixture of air and fuel at very high temperatures, causing the turbine blades to spin.
- The spinning turbine drives a generator that converts the energy into electricity.
- The gas turbine can be used in combination with a steam turbine in a combined-cycle power plant to create power extremely efficiently.

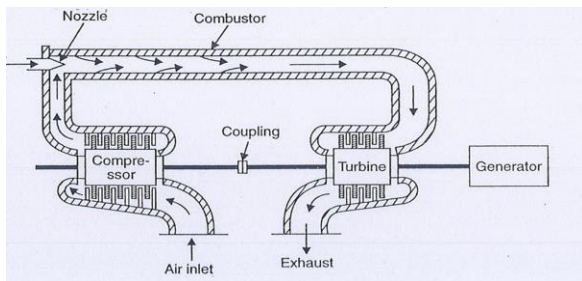

### Gas Turbine Power Plant

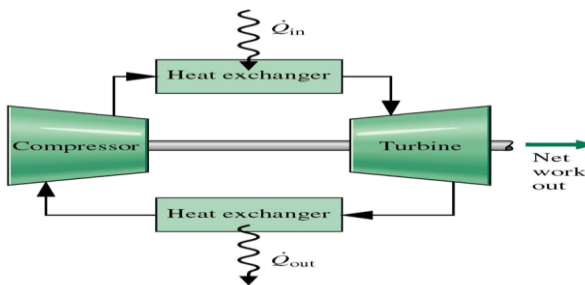

### Closed Cycle Gas Power Plant

- A closed cycle gas turbine is a turbine in which the air is circulated continuously within the turbine.
- The components of this turbine are a compressor, heating chamber, the gas turbine which drives the generator and compressor, and a cooling chamber.

The main components of the simplest form of a closed cycle gas turbine are:

#### 1. Compressor:

- It is used to compress the gas.

#### 2. Heating chamber:

- The heating of the compressed gas is taking place in the heating chamber.

### 3. Gas turbine:

- It is used to produce useful work that is used by the generator to generate electricity.

### 4. Generator:

- It generates electricity with the help of the gas turbine.

### 5. Cooling chamber:

- The cooling of the gas after passing from the turbine takes place in the cooling chamber.

### Open cycle Gas Turbine

- An open cycle gas turbine can be defined as a combustion turbine plant that is fired up using liquid fuel for rotating a generator so that electricity can be produced.
- The major components used in the open cycle gas turbine include a compressor, combustion chamber, turbine, control & start-up.
- A compressor uses the air from the environment & reduces it throughout several stages within the compressor.
- The liquid fuel can be supplied to a combustion chamber where the chamber includes compressed air.
- After that, the mixture of both air and fuel can be ignited to form gas with high velocity.
- The gas can be supplied using the turbine blades to make the shaft ON that is connected to the rotor within the generator.
- The rotation of the rotor can be done within a stator so that electricity can be generated.
- After that, this electricity can be supplied through the network of high voltage wherever it is required
- The fresh air enters at ambient temperature into the compressor.
- The air with high force can be entered into the chamber of combustion where the liquid fuel can burn at stable force.

The gas with high temperature can enter into the turbine wherever it increases to ambient force and generates electricity

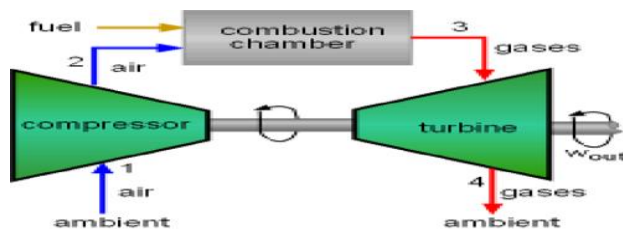

### Open cycle Gas Turbine

------(10 Marks)

7. (a) **The factors to be considered for site selection of diesel electric plant**

- **Distance from load centre** : The site should be as near to the load centre as possible in order to avoid transmission costs and losses
- **Availability of Land** : The land should be available at a cheaper rate to keep the capital cost of the plant to the reasonable one
- **Availability of fuel** : The fuel should be easily available and at reasonable rate
- **Availability of Transportation facilities** : The transportation facilities should be available
- **Availability of water** : Water should be available in sufficient quantity for cooling purposes
- **Distance from populated areas** : The site should be away from thickly populated area because of noise and nuisance caused from exhaust
- **Type of Land** : The land should be of high bearing capacity to withstand the load of the plant and also vibrations transmitted to the foundations from compressors and diesel engines

------(5 Marks)

7(b) **Electrostatic Precipitator**

- It essentially consists of two sets of electrodes which are completely insulated from each other and a high voltage electrostatic field is maintained across them
- One set called the emitting or discharging electrode is in the form of thin wires and the other set is called the collecting electrode
- The emitting or discharge electrodes are placed in the centre of the pipe in case of tubular type precipitator (or midway between two plates in case of plate type precipitator) and are connected to negative polarity of HVDC source(25 – 100 kV) while the collecting electrodes are connected to the positive polarity of the source and are earthed
- High electrostatic field thus set up between the two sets of electrodes creates corona discharge and ionizes the gas molecules as the flue gases flows through the tube or in between the plates
- The dust particles in the gas acquire negative charge and are attracted to the electrodes connected to the positive polarity(collecting electrodes) and get deposited there
- The deposited dust is made to fall off the electrodes when rapped mechanically
- The electrostatic precipitator maybe (a)plate or tubular type (b)horizontal flow or vertical flow type (c)dry or wet type

- In case of wet type or irrigated precipitator, the deposited dust is removed by a water film flowing down on the inner side of the collecting electrodes
- Usually, a dry type electrostatic precipitator is employed

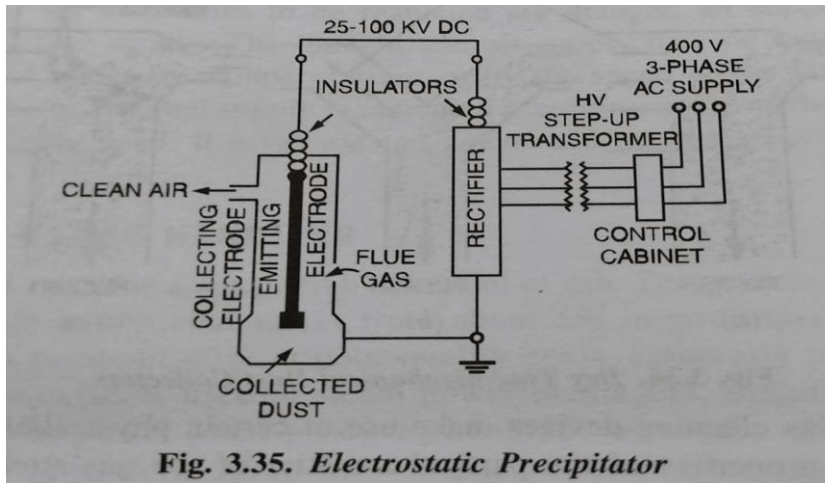

**Fig. 3.35. Electrostatic Precipitator**

------(5 Marks)